

REVISION HISTORY

ZONE	REV	DESCRIPTION	DATE	BY
-	00	ORIGINAL ISSUE	6/18/15	GCP

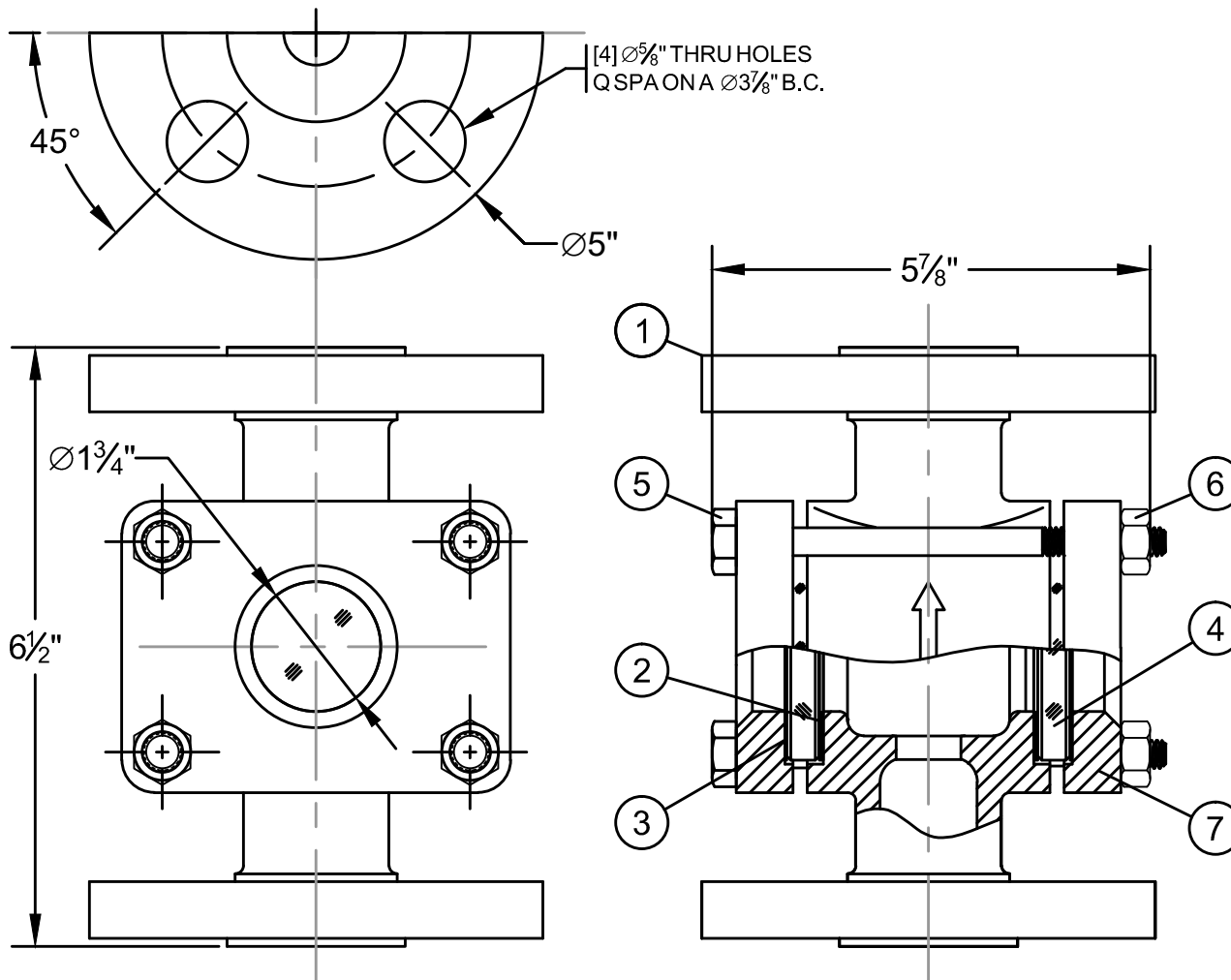

Notes:

- Raised face flanged ends drilled to match 1 1/2" 150# ANSI B16.5.
Options include:
 - Flat Face 150# ANSI B16.5
 - MIL-F-20042
 - DIN
- Standard body materials include:
 - A216 Grade WCB
 - A351 Grade CF8M
 - A182 T304/304L
 - A182 T316/316L
 - A62 Bronze
 - Other alloys available upon request.
- Standard Lens Material Tempered Borosilicate. Options include:
 - Fused Quartz
 - Non-Glass Plastics
 - Kel-F, Mica or PFA lens shields
- Standard lens retainer materials:
 - A216 Grade WCB
 - A351 Grade CF8M
 - A182 T304/304L
 - A182 T316/316L
 - Other alloys available upon request.
- Standard seal gasket choices include:
 - EPDM
 - Expanded PTFE
 - Silicone
 - others upon request.
- Standard fastener materials:
 - A193 B7 Bolt / A194 2H Nut
 - A193 B8 Bolt / A194 G8 Nut
 - Other alloys available upon request
- Perform ambient temp. hydrotest at 1.5x operating pressure.
- All units supplied with a 304 Stainless Steel Tag.
- Max Rating 150PSI/FV@500°F. Dependant on gasket and lens choice.

INDICATOR OPTIONS

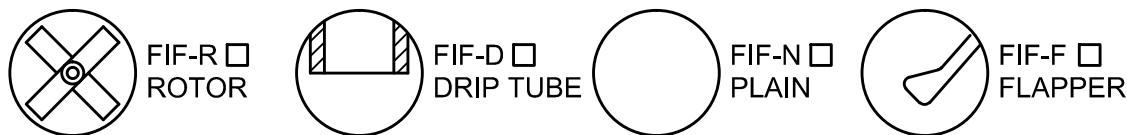

THIS DRAWING IS THE SOLE PROPERTY OF THE J.G. PAPAILIAS COMPANY, INC AND NEITHER THE DOCUMENT NOR THE INFORMATION CONTAINED HEREIN SHALL BE COPIED, REPRODUCED, DISCLOSED OR TRANSFERRED EXCEPT AS AUTHORIZED IN WRITING BY AN OFFICER OF THE J.G. PAPAILIAS CO., INC.

2	7	XXXX-XXXX-XXXX	LENS RETAINER
4	6	XXXX-XXXX-XXXX	HEX NUT
4	5	XXXX-XXXX-XXXX	HEX BOLT
2	4	XXXX-XXXX-XXXX	LENS
2	3	XXXX-XXXX-XXXX	LENS CUSHION
2	2	XXXX-XXXX-XXXX	SEAL GASKET
1	1	XXXX-XXXX-XXXX	BODY

QTY	SYM	PART NUMBER	DESCRIPTION
-----	-----	-------------	-------------

BILL OF MATERIAL

SIZE	CAGE CODE	DRAWING NUMBER	REV
B	1Z740	03E024	0
SCALE: NTS		EST. WEIGHT: 12 LB	SHEET: 1 OF 1

MODEL#: 1 1/2" FIF
1 1/2" 150# FLANGED SIGHTFLOW INDICATOR

PAPAILIAS
INCORPORATED
245 PEGASUS AVE, NORTHVALE, NJ 07647 | [201]767-4027 WWW.PAPAILIAS.COM